

● 外观图/DIMENSION (单位/UNIT: mm)

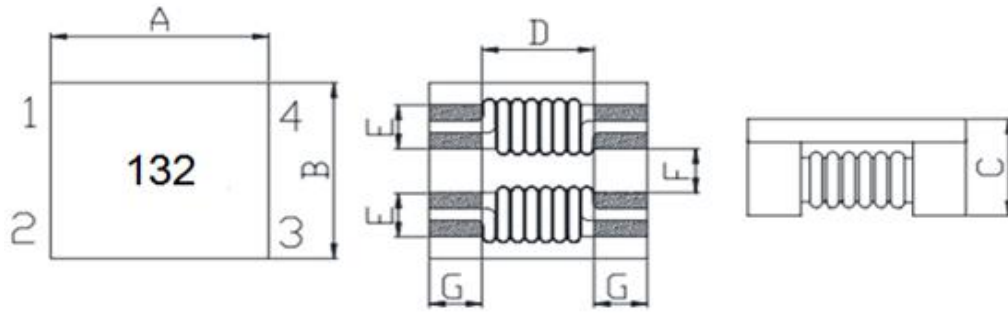

A:7.0±0.5 B:6.0±0.5 C:3.8 MAX D:3.5 TYP E:1.5±0.2 F:1.5±0.2 G:1.75±0.2

● 电路图/CIRCUIT DIAGRAM

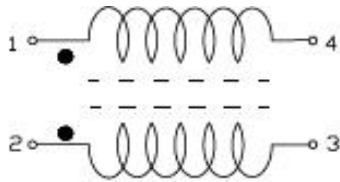

● 注意事项/NOTE:

1. 印字
2. 線方向按照圖示作業

● 电气特性/ELECTRICAL CHARACTERISTIC

品名	Z (Ω) 100MHz/0.1V		DCR (Ω) MAX	额定电流 (A) MAX	绝缘阻抗 (MΩ) MIN	额定电压 (V) MAX	印字 内容
	MIN	TYP					
GCM7060SE-400T	40	70	5m	15.00	10.00	125	400
GCM7060SE-301T	225	300	10m	5.00	10.00	125	301
GCM7060SE-501T	275	450	15m	5.00	10.00	125	501
GCM7060SE-601T	500	650	15m	4.00	10.00	125	601
GCM7060SE-701T	500	700	15m	4.00	10.00	125	701
GCM7060SE-102T	800	1000	17m	3.00	10.00	80	102
GCM7060SE-132T	910	1300	21m	2.50	10.00	80	132

1. 1. IDC: ΔL=40°C Typ

● 材料清单/MATERIAL LIST

NO.	ITEM	DESCRIPTION
1	CORE	FERRITE
2	WIRE	Grd1-P180
3	SOLDER	Sn99.3: Cu0.7
4	MARK	BLACK
5	胶带	單面膠
6	胶水	Epoxy

● 编带规格/TAPING SPECIFICATIONS

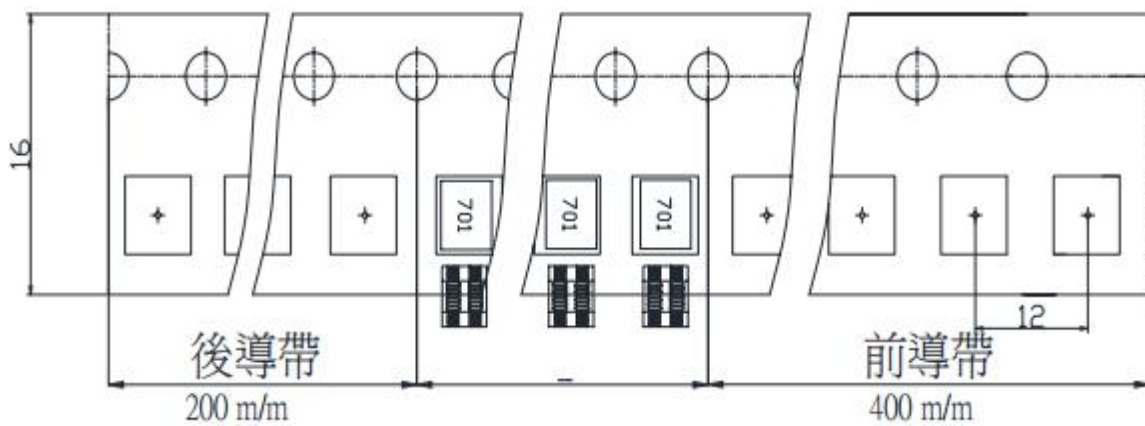

Transparent carrier and cover tape/透明载带和自粘上带

Adhesive strength of cover tape is 20 to 120 gf
The conduction band direction

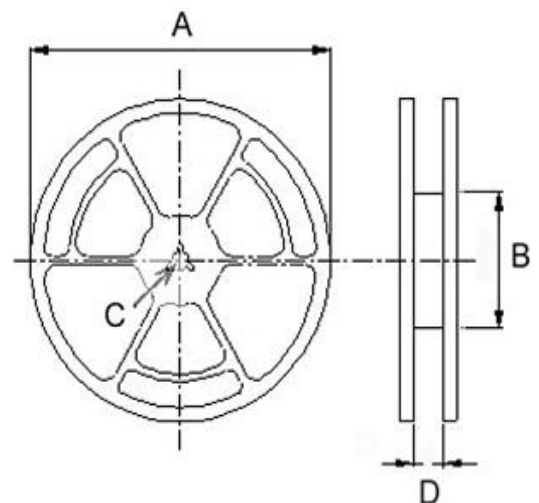
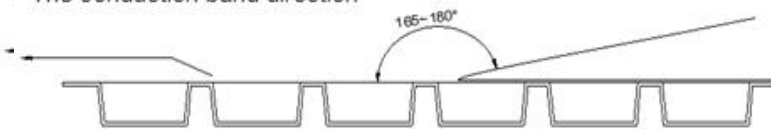

Reel Dimensions (Unit: mm)				Quantity
A	B	C	D	Pcs/Reel
330	100	13	16.5	1500

● 可靠性测试/RELIABILITY TESTING

Operating Temperature	- 40 to +125 °C (Contain Heating coil)
Appearance Inspection	No external defects by visual inspection
Terminal Strength	After soldering , between copper plaet and terminals of coils , push in two directions of X , Y with standing 10N(1.02kg) for10+/-2 sec. Terminal should not peel off. (Refer to figure at right)
Heat endurance of reflow soldering	Refer to figure
Insulating resistance	Over 100 MΩ at 100V D.C . between wire and core
Dielectric Strength	Apply at 0.5KV 3mA for 1 minute between wire and core
Temperature characteristics	Inductance coefficient (0~2,000) × 10 / °C (- 40~ + 125 °C)
Humidity characteristics	Inductance deviation within ± 10% , after 96 hours in 90~95% relative humidity at 40 ± 2 °C and 1 hours drying under normal
A test is made under the above mentioned condition , and it is kept for 2 hours in the normal	

IR Reflow profile

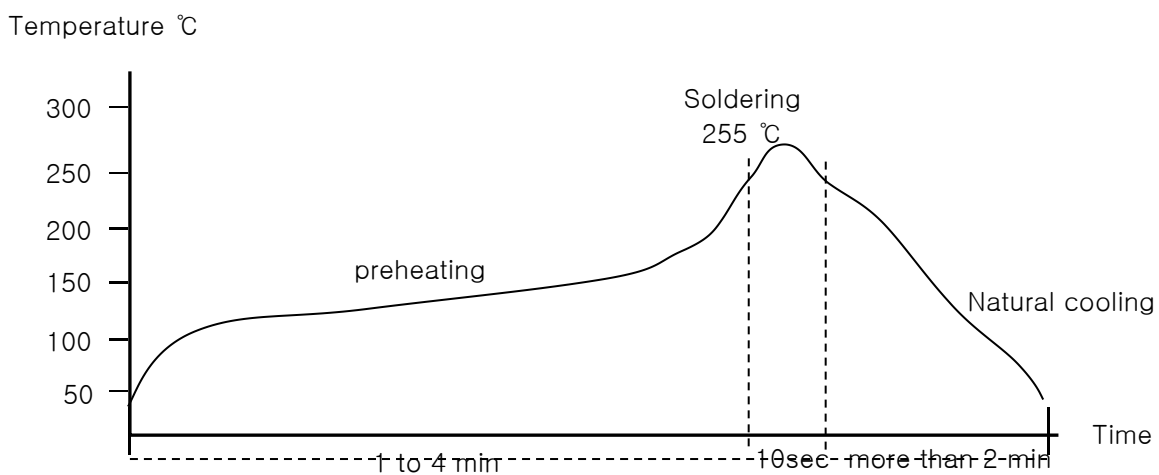

Temperature and humidity . After that , no mechanical and electrical defect should be found .

● 包装方式/PACKING LIST

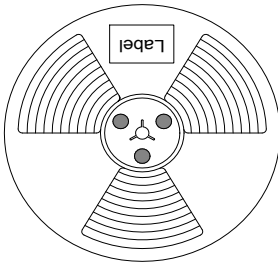

1、轮盘规格：13'（直径330mm）
数量：1500PCS/盘

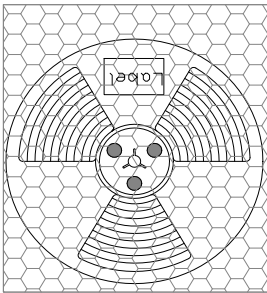
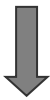

2、数量：1500PCS/袋.

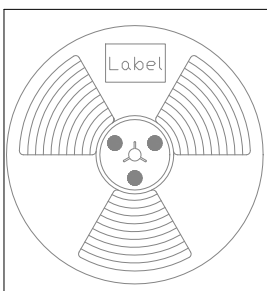
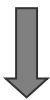

3、数量：4500PCS/盒

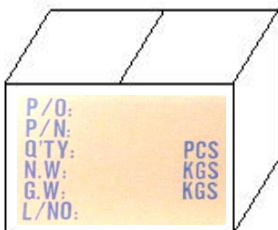

4、数量：22500PCS/箱。
作业说明：当尾数箱不足一整箱时需用内盒或填充物装满。